

- (A) Zastavbovy rozmer / In-built dimension / Baumaße
- (B) Litinový odvod kouře / Cast iron spigot / Der gusseiserne Rauchabgang
- (C) Centralni privod vzduchu / Central air inlet / Zentralluftzufuhr
- (D) Primarni a sekundarni vzduch / Primary and secondary air / Primärluft und Sekundärluft
- (L) Volna plocha proskleni / Free glass area / Freie Glassichtfläche

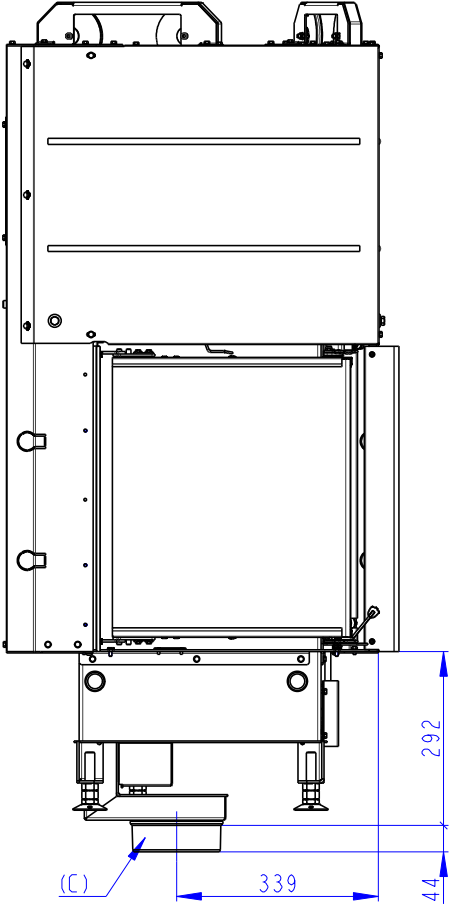

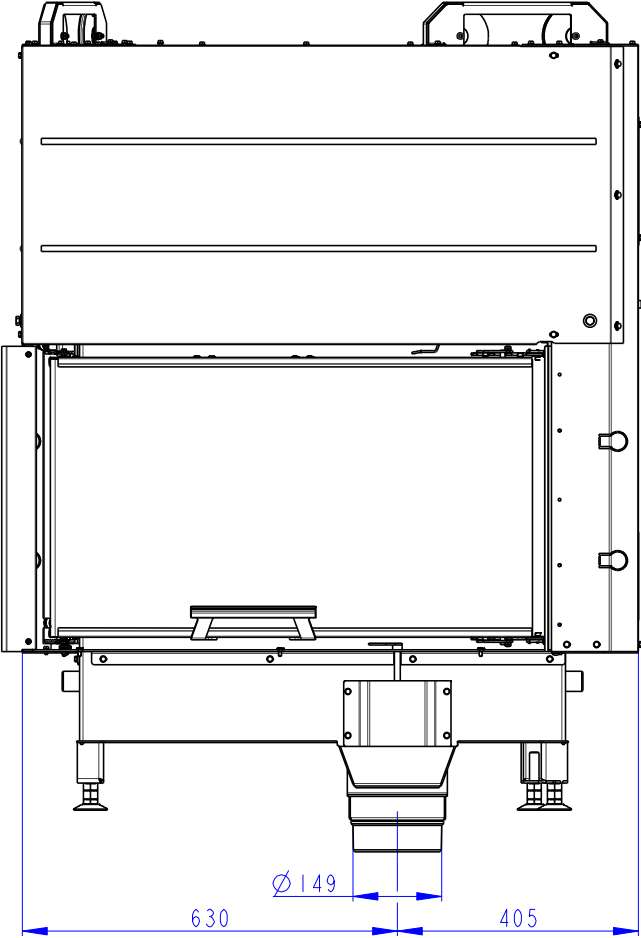

NELZE KOMBINOVAT SE SADAMI AKUMULACI AKKUM KV 02, AKKUM KV 03
UNABLE TO COMBINE WITH ACCUMULATION SETS AKKUM KV 02, AKKUM KV 03
NICHT KOMBINIERBAR MIT SPEICHERSATZ AKKUM KV 02, AKKUM KV 03

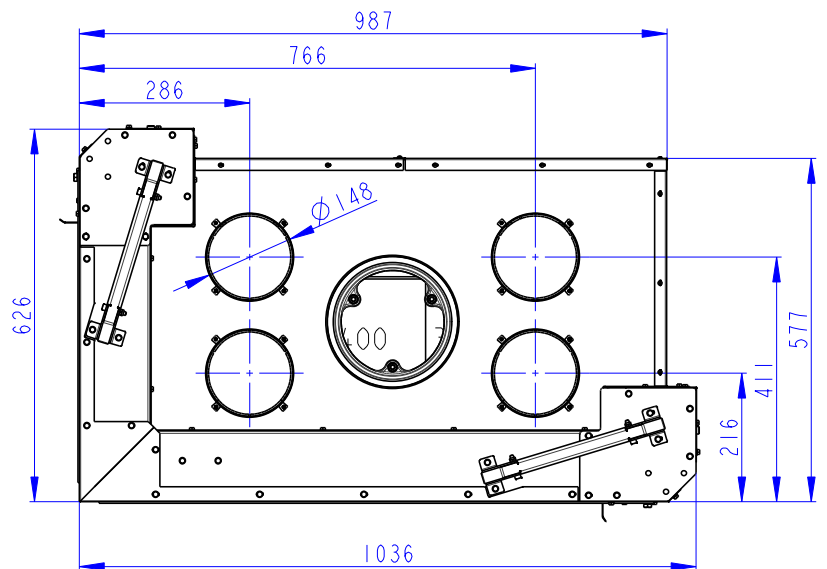
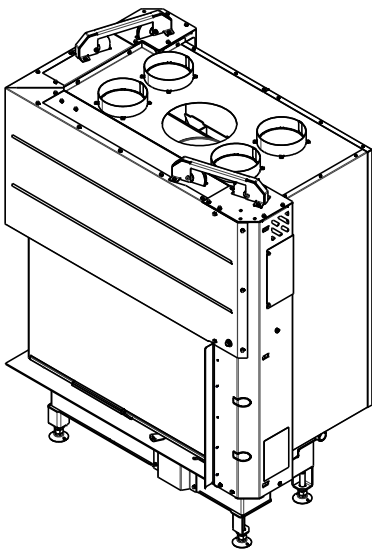
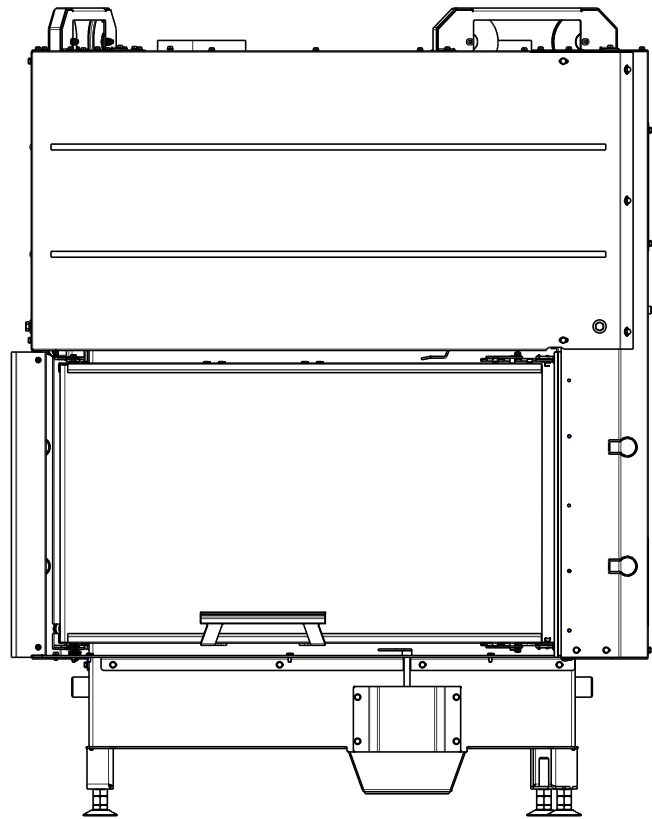
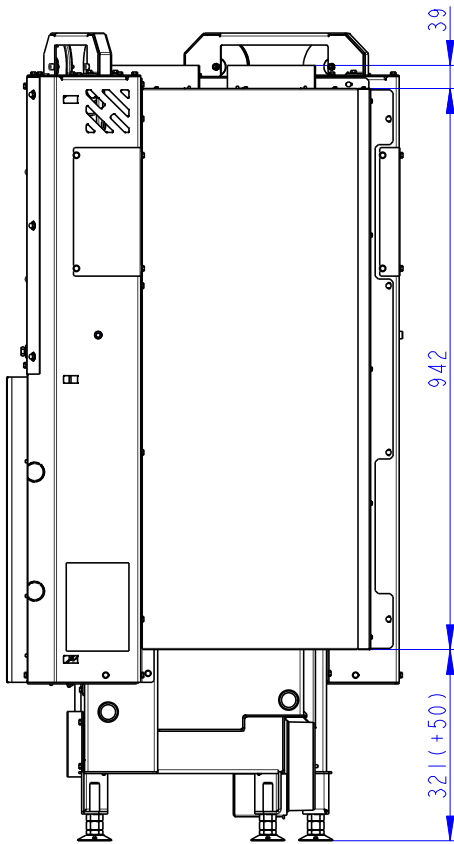
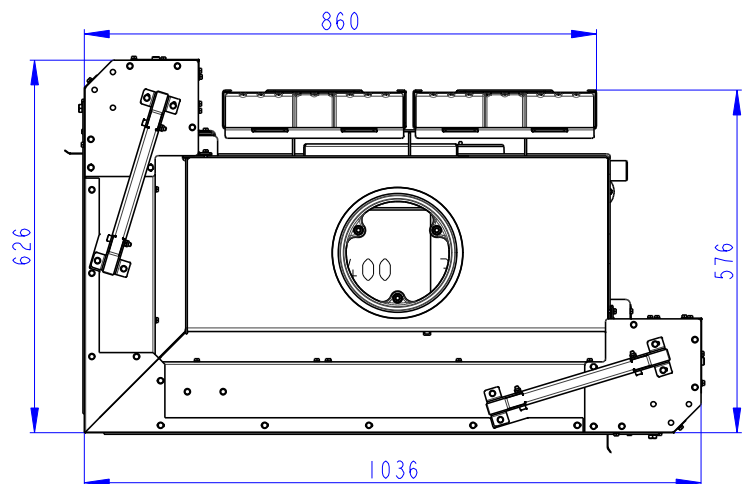
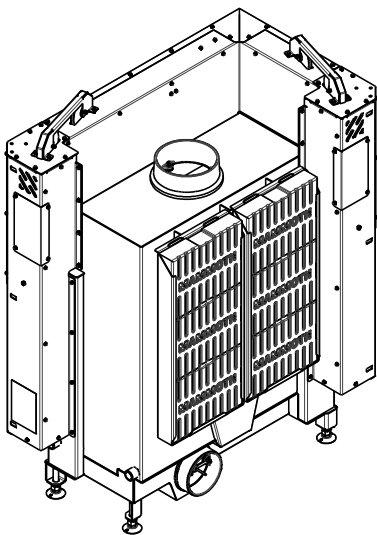
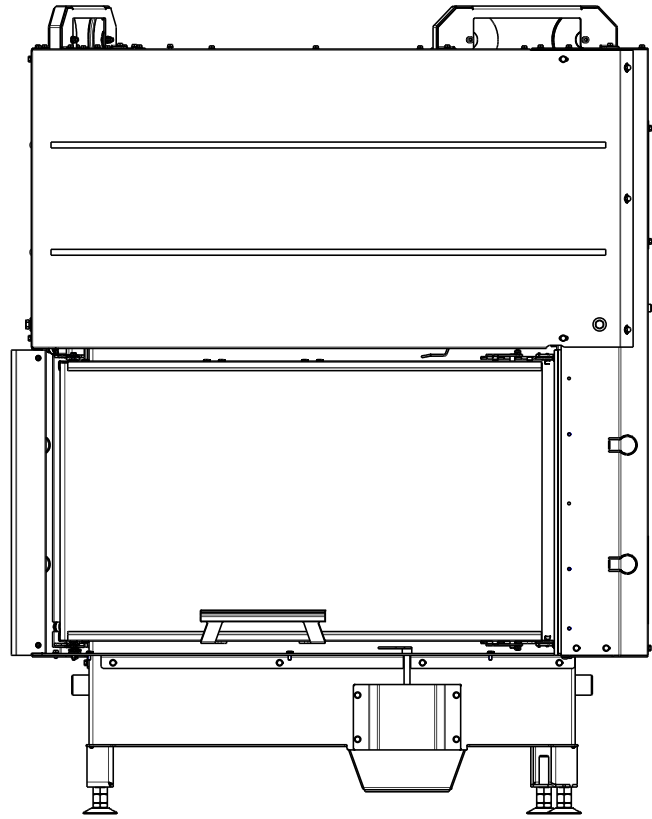
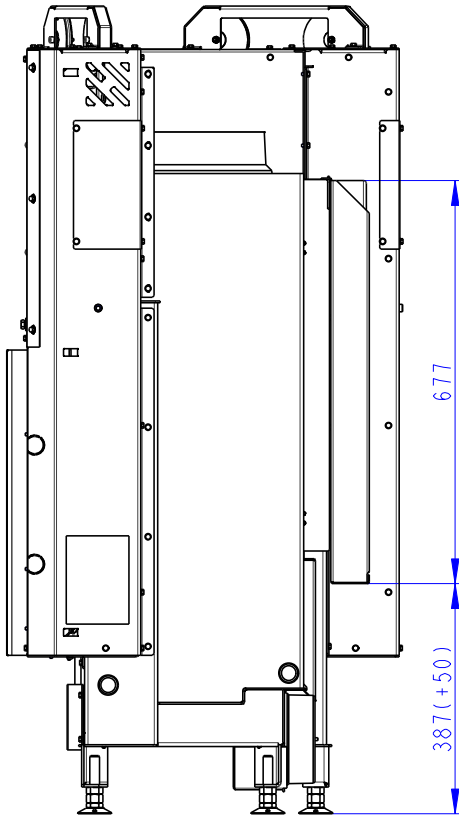

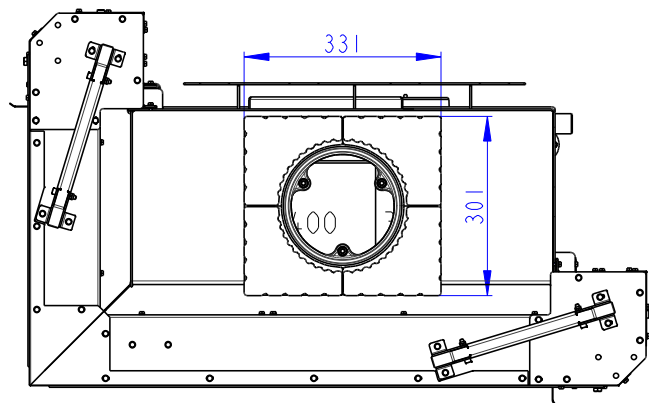
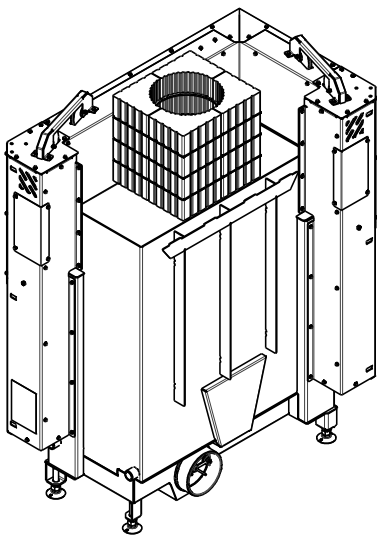
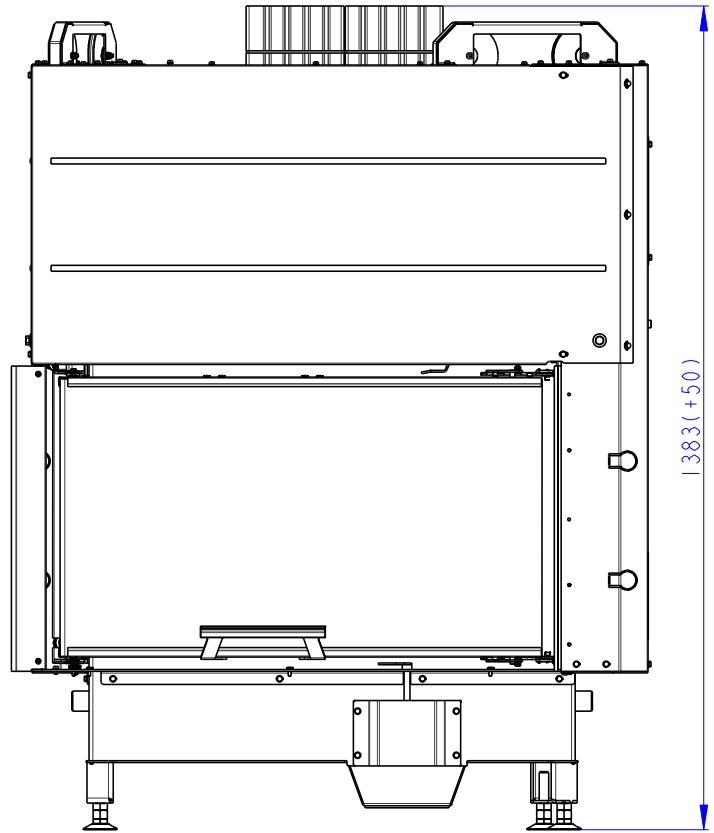
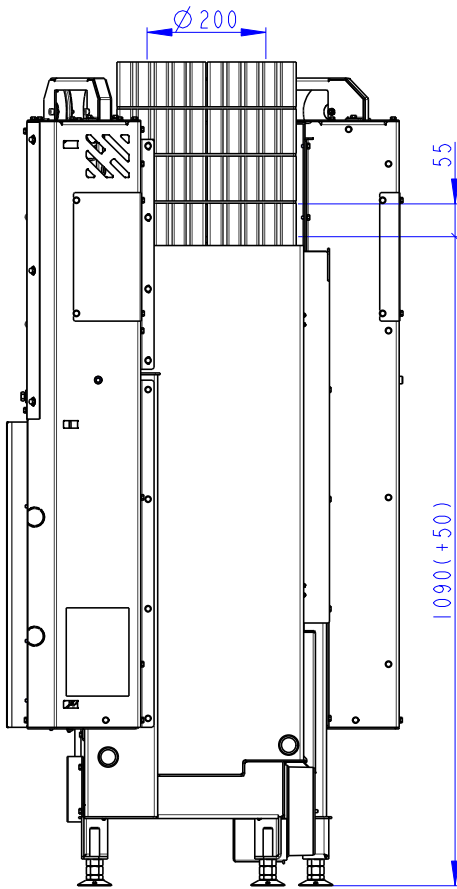

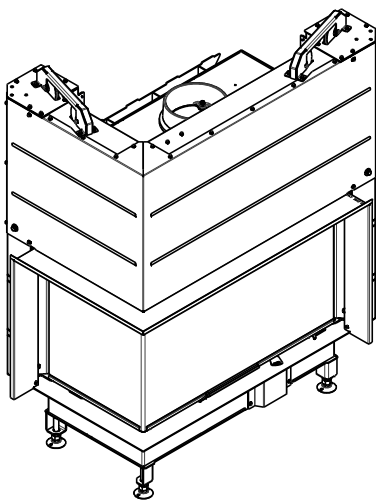
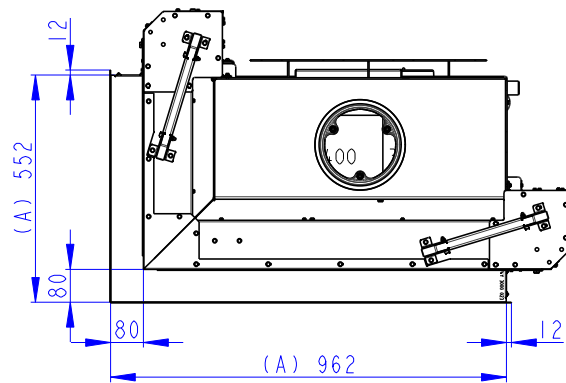
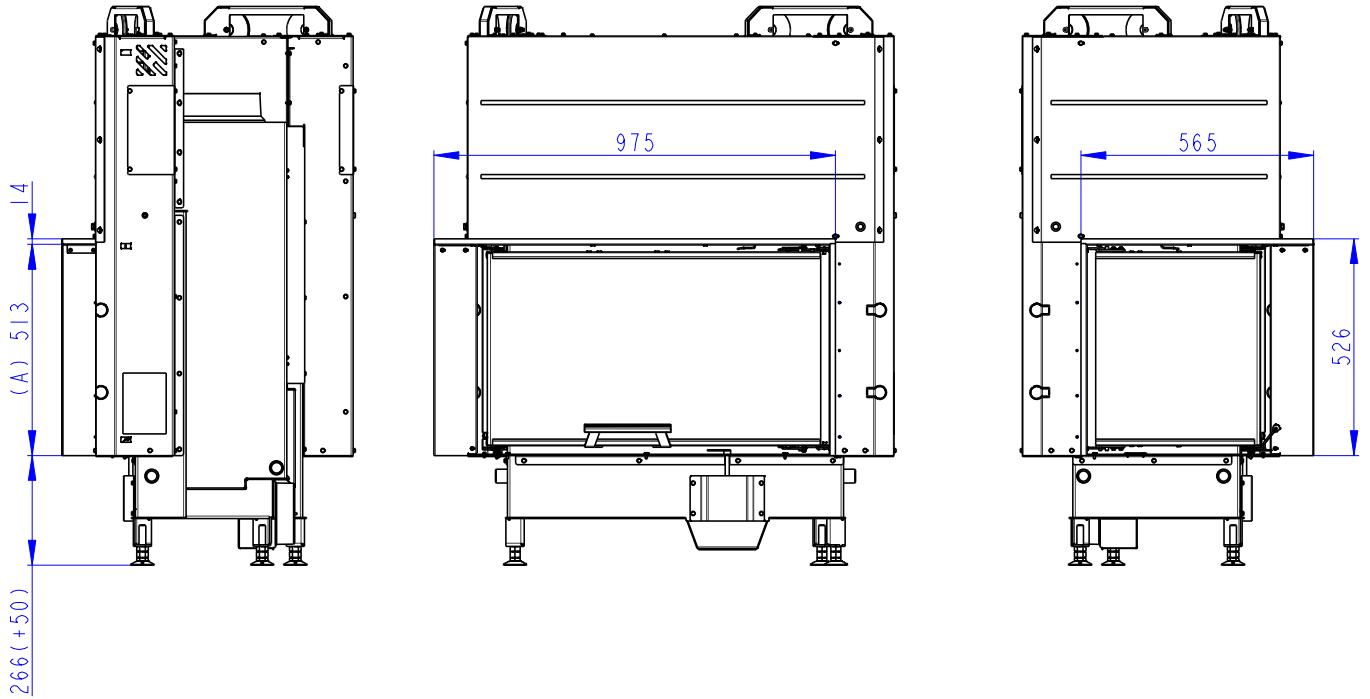

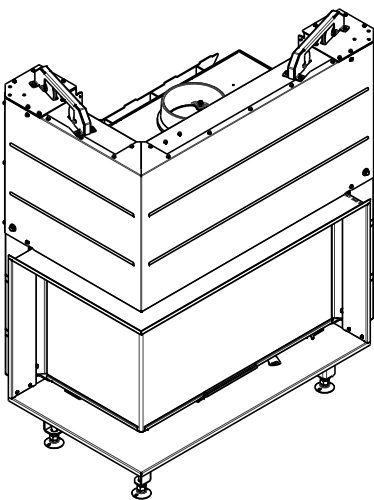
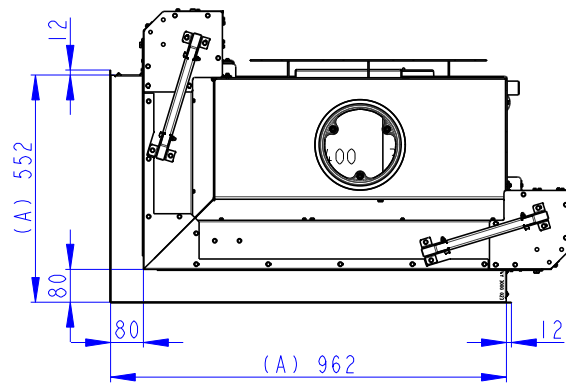
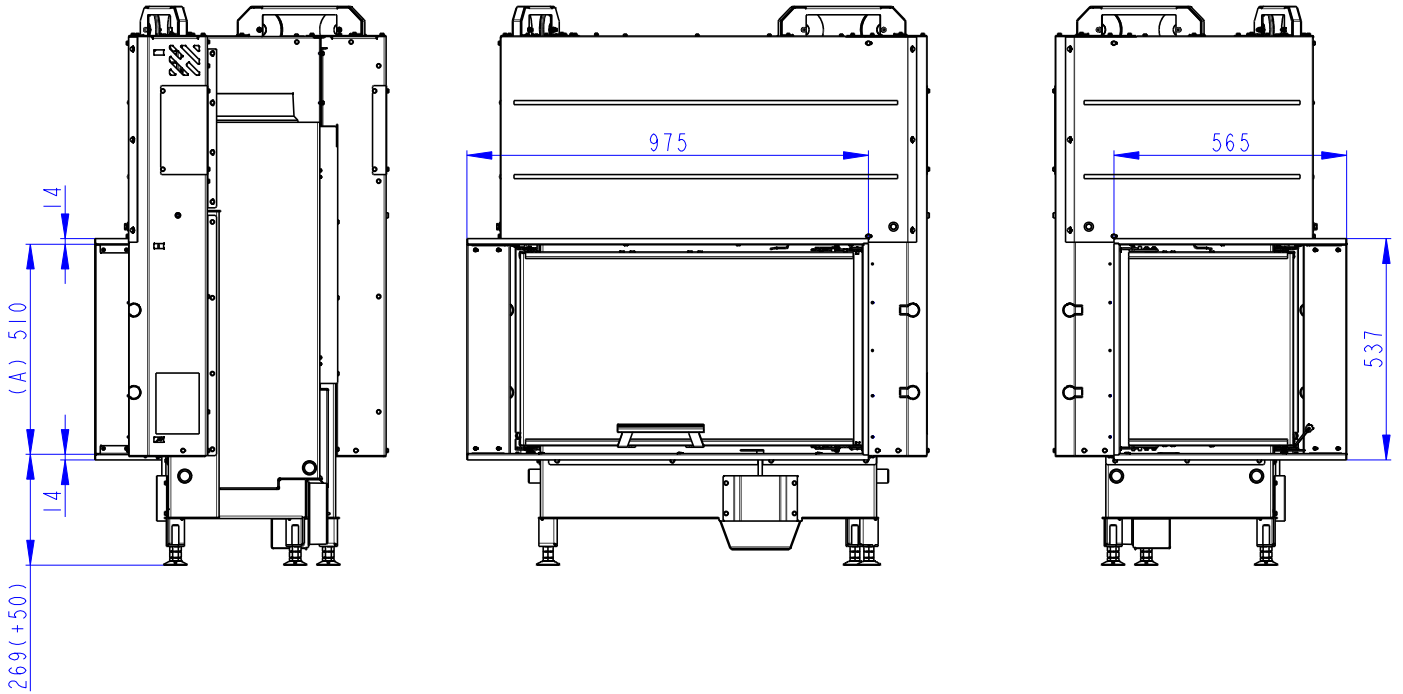

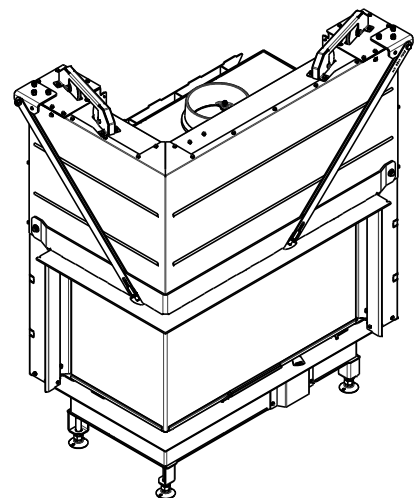
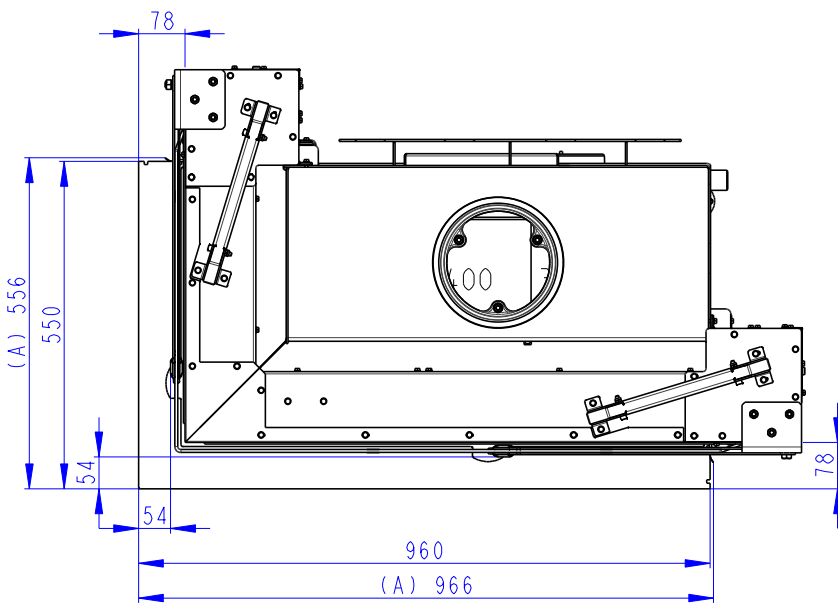
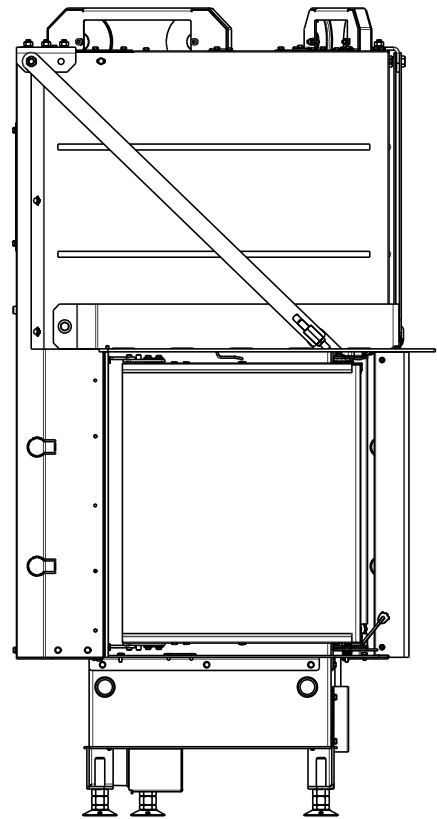
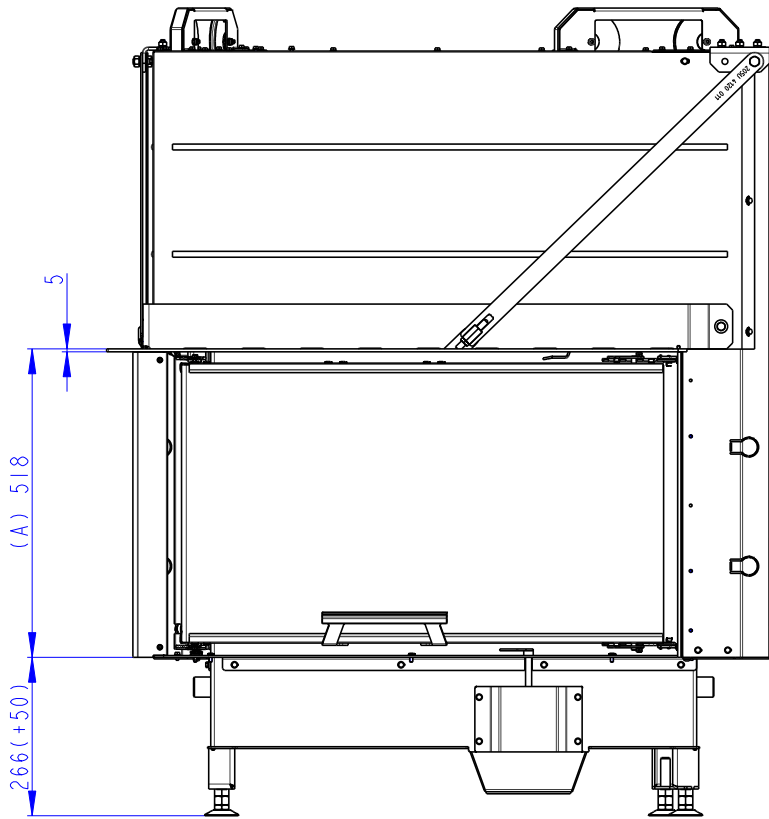

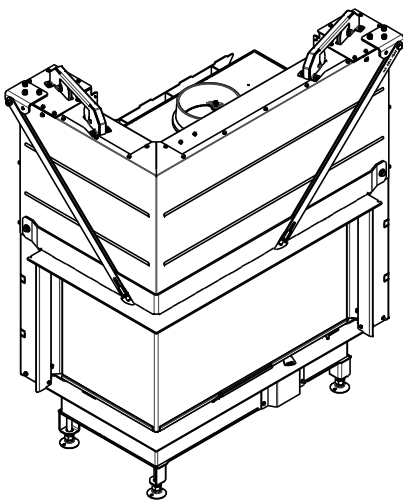
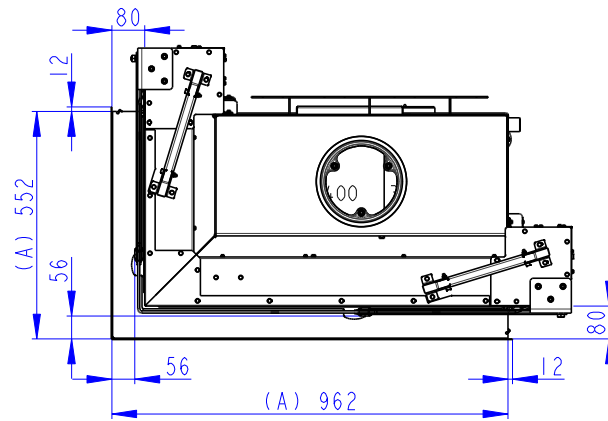
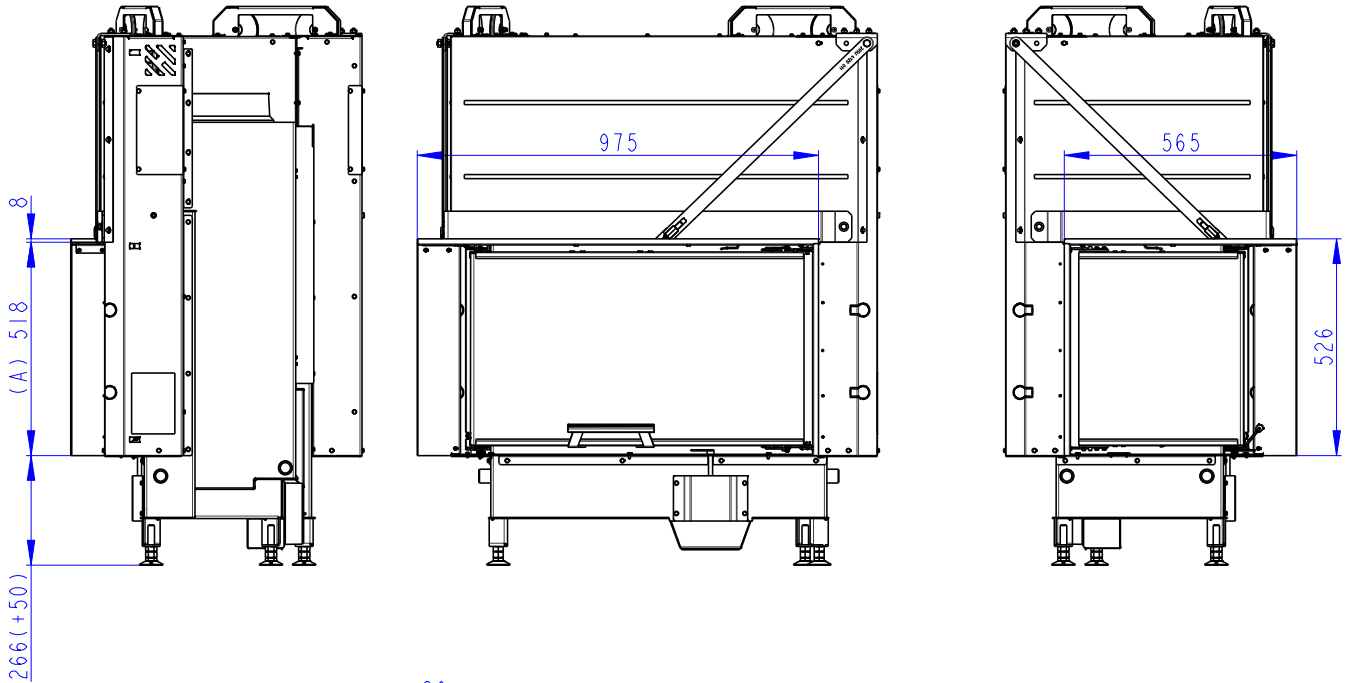

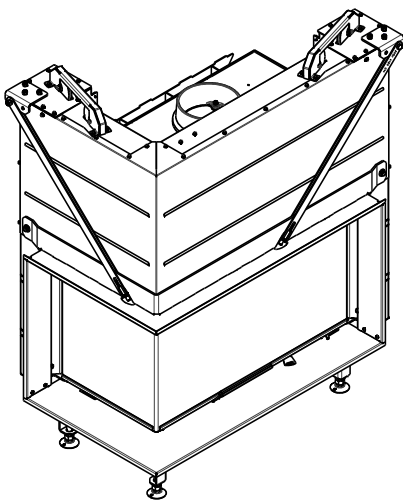
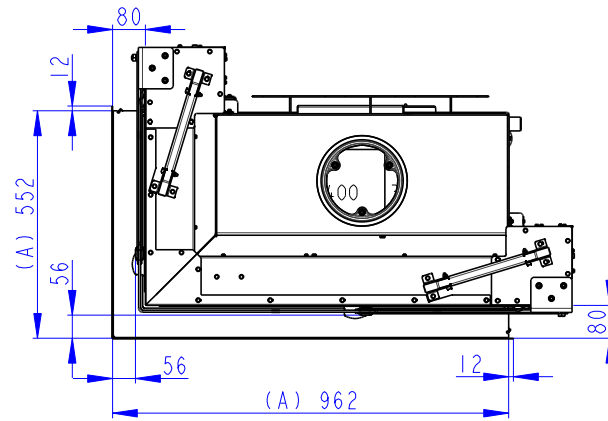
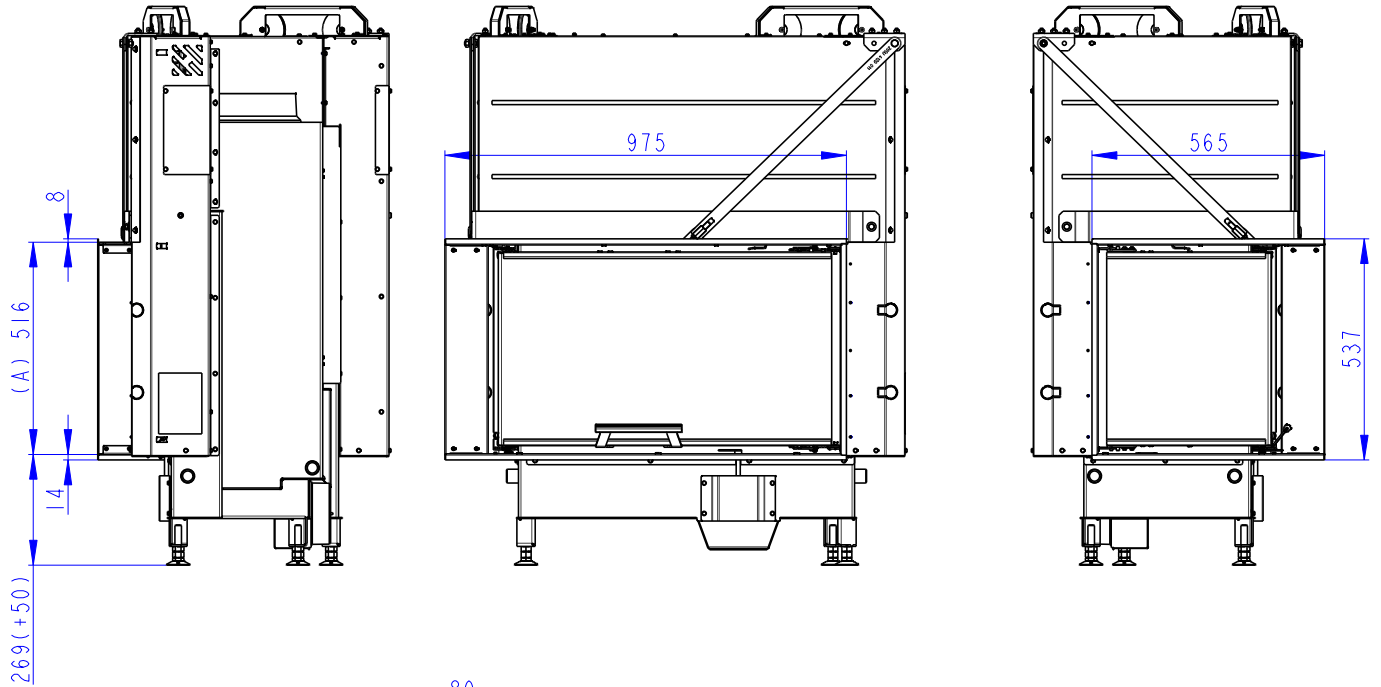

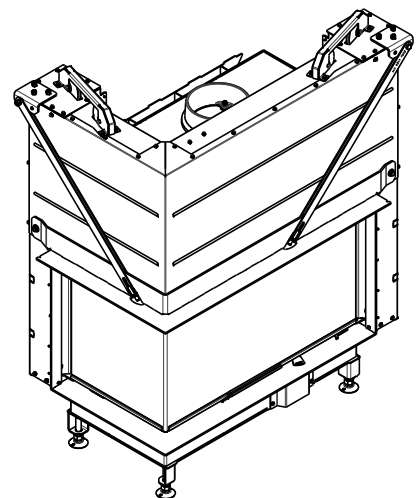
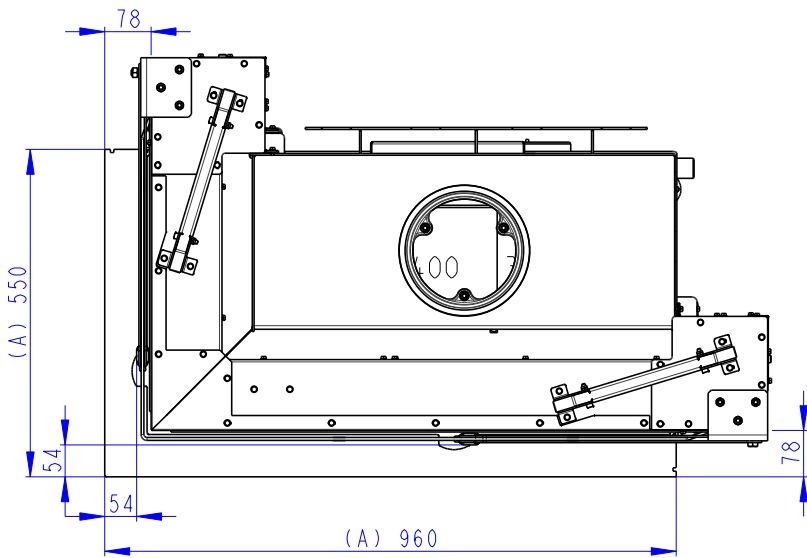
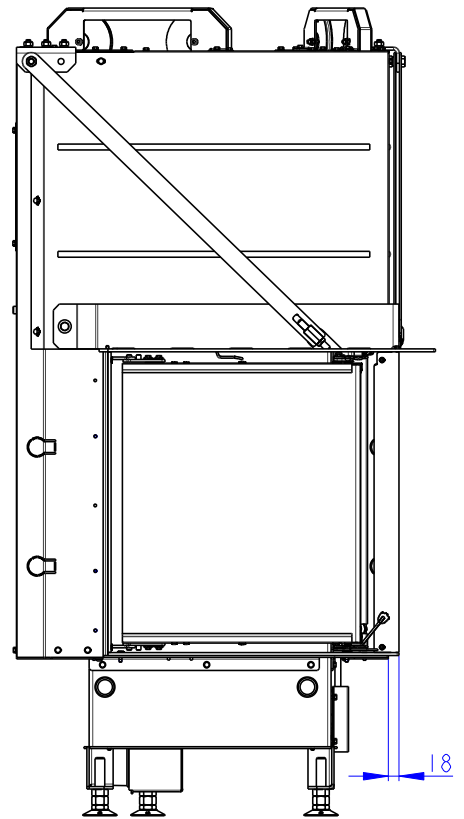
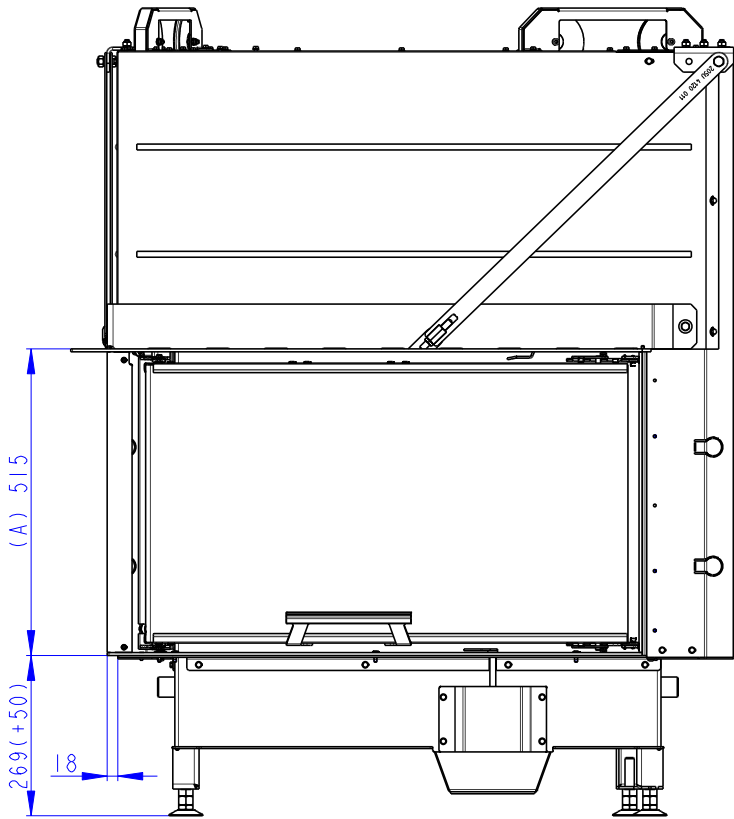

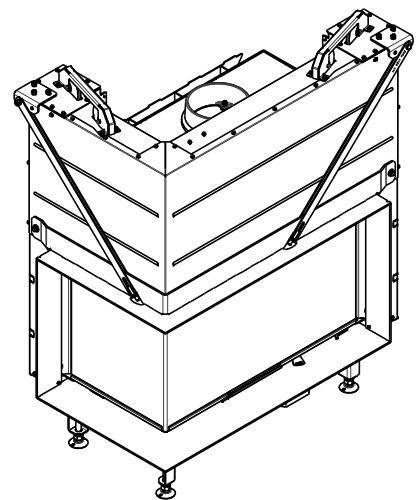
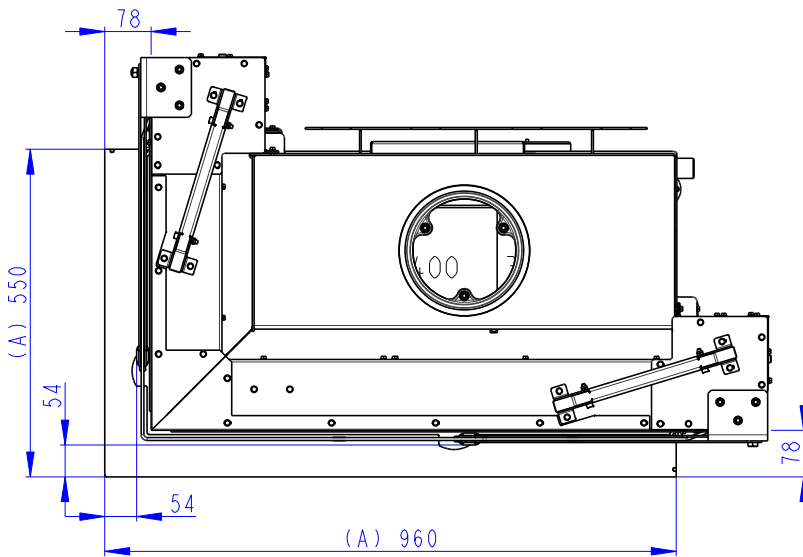
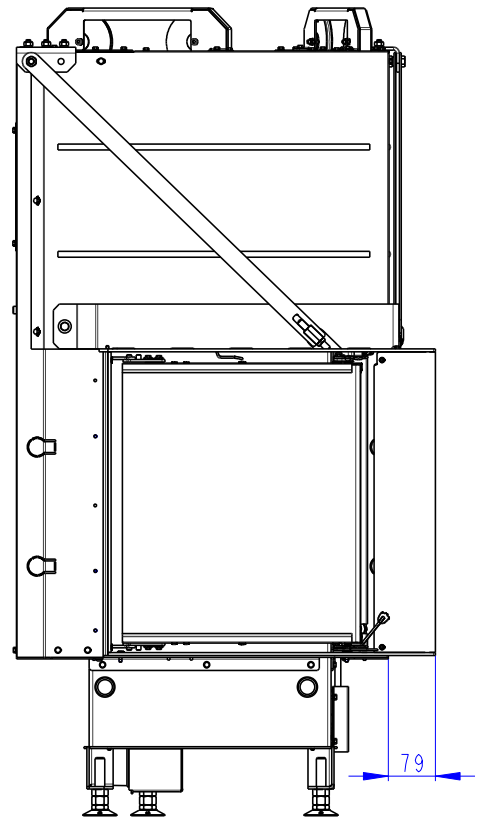
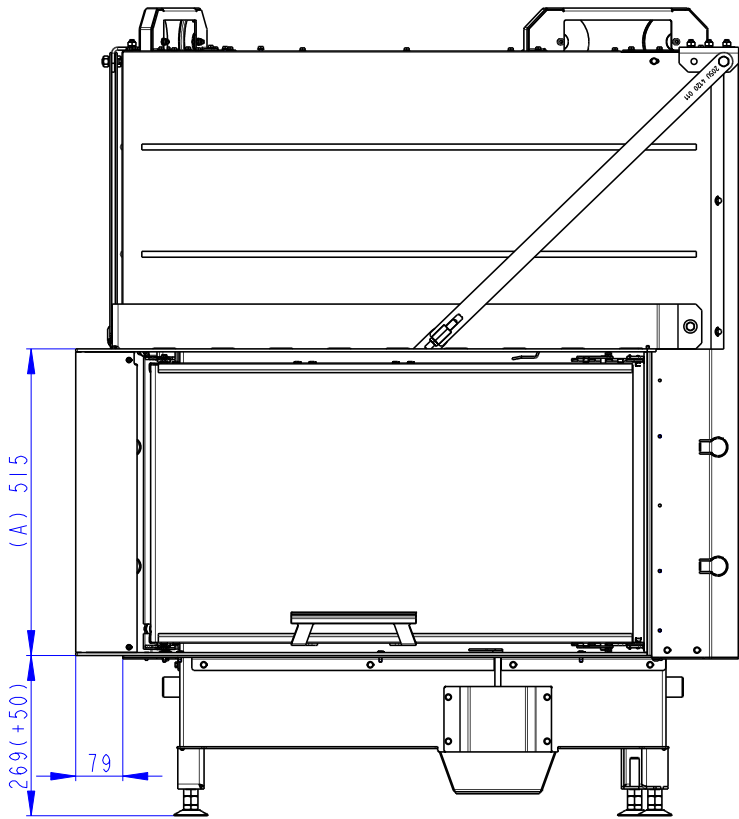

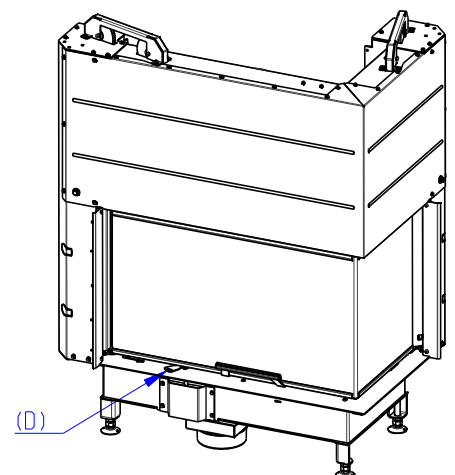
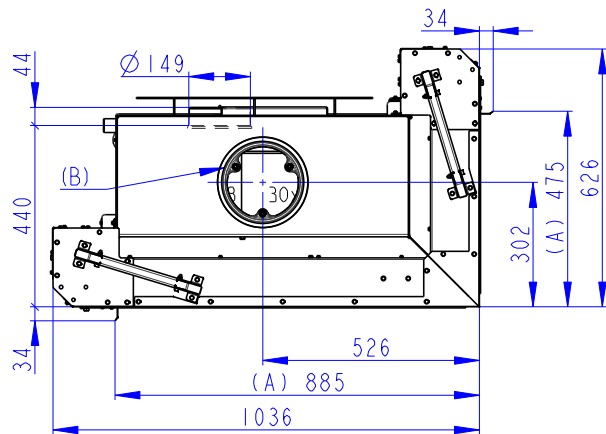
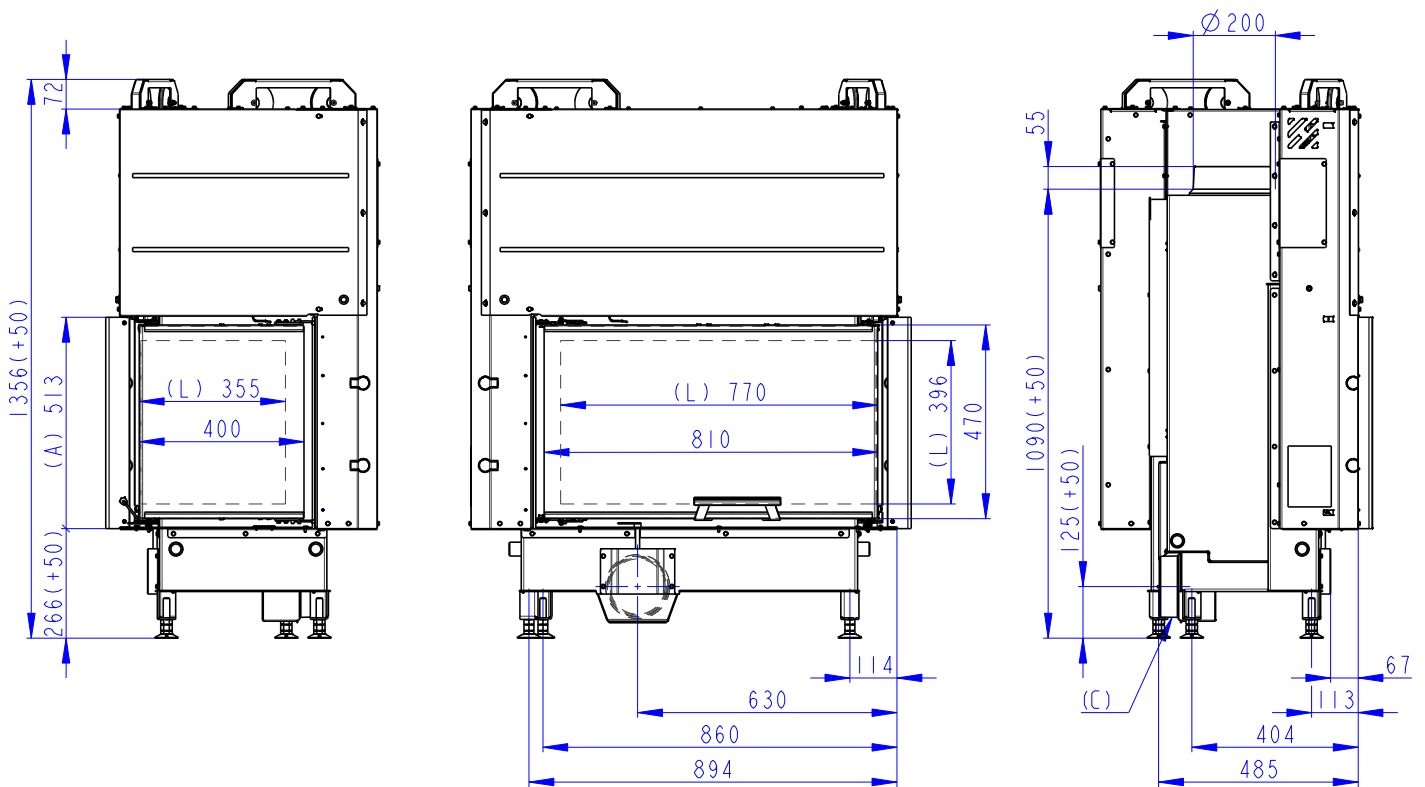

- (A) Zastavbovy rozmer / In-built dimension / Baumaße
- (B) Litinový odvod kouře / Cast iron spigot / Der gusseiserne Rauchabgang
- (C) Centralni privod vzduchu / Central air inlet / Zentralluftzufuhr
- (D) Primarni a sekundarni vzduch / Primary and secondary air / Primärluft und Sekundärluft
- (L) Volna plocha proskleni / Free glass area / Freie Glassichtfläche

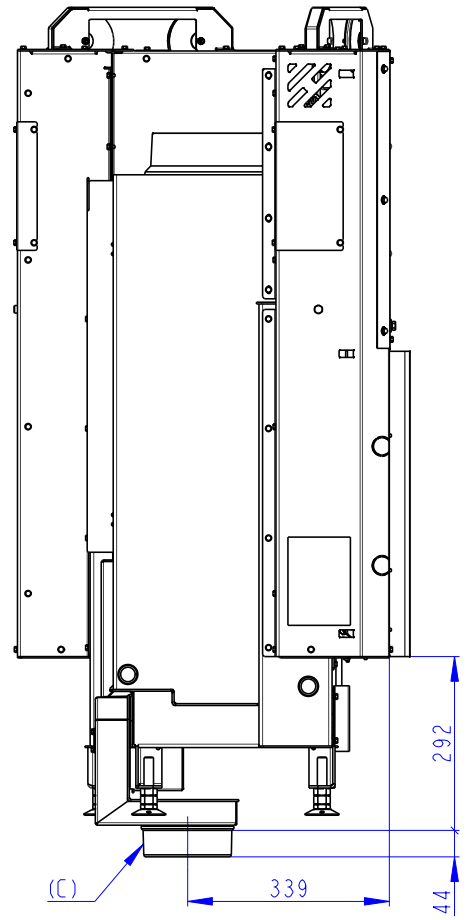
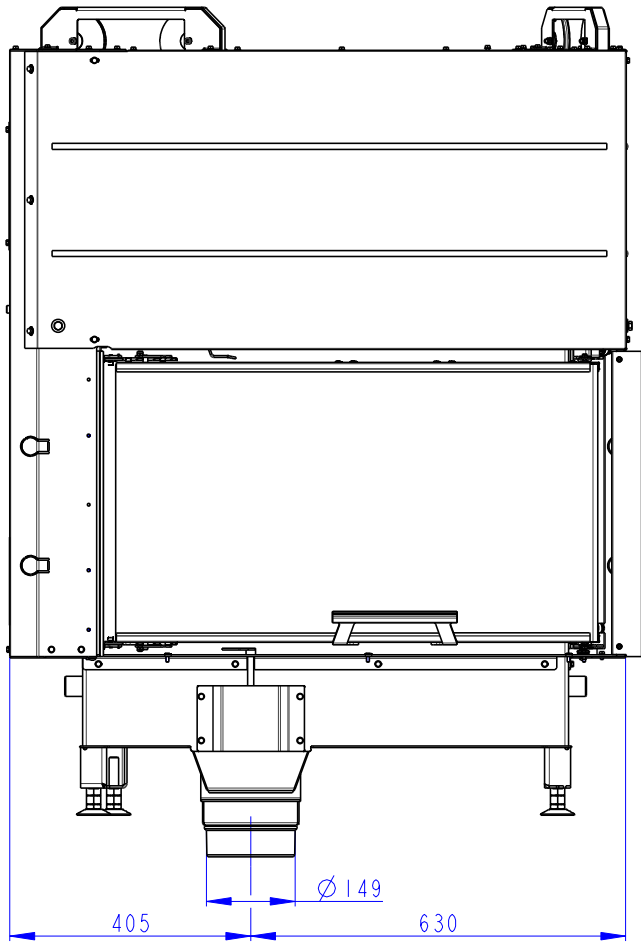

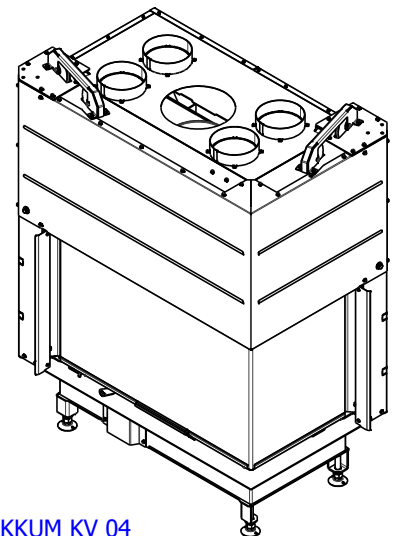
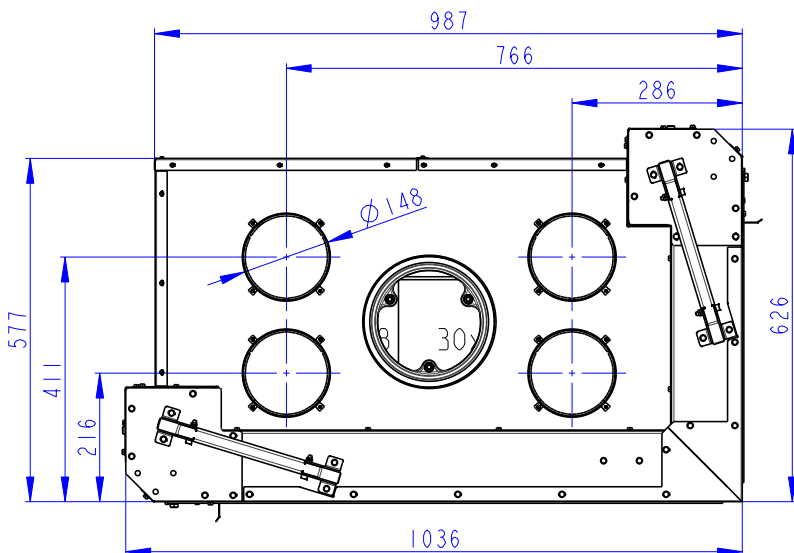
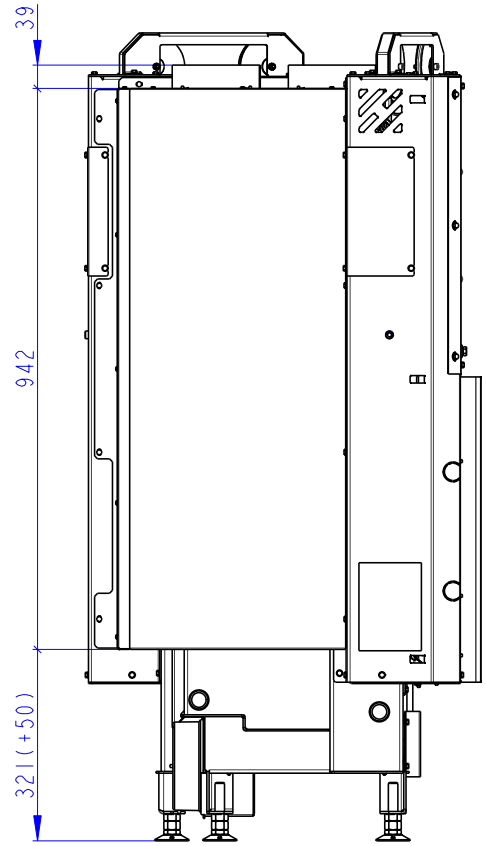
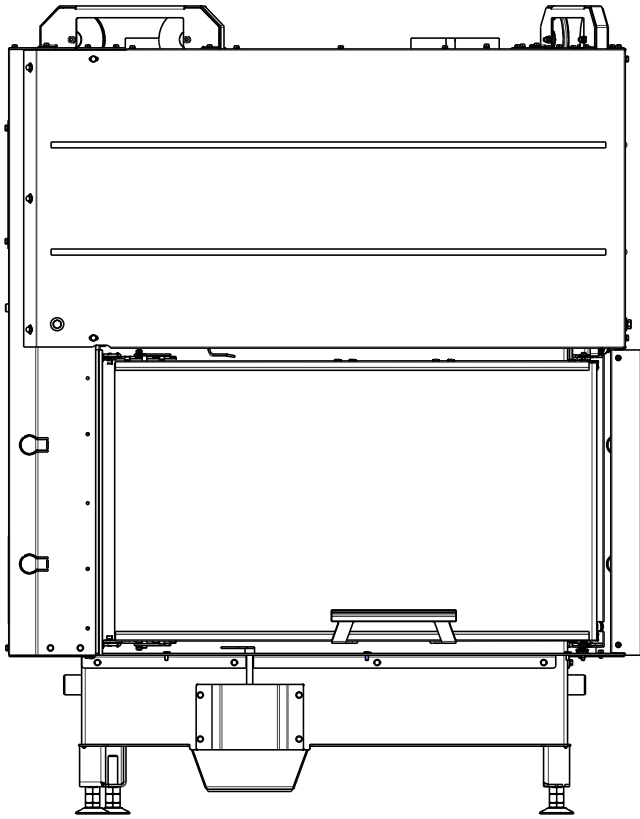

NELZE KOMBINOVAT SE SADAMI AKUMULACI AKKUM KV 02, AKKUM KV 04
UNABLE TO COMBINE WITH ACCUMULATION SETS AKKUM KV 02, AKKUM KV 04
NICHT KOMBINIERBAR MIT SPEICHERSATZ AKKUM KV 02, AKKUM KV 04

